

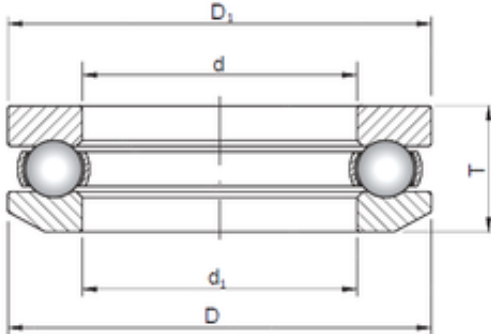

ISO 53407 thrust ball bearings



Bearing No. 53407

Bore Diameter	35 mm
Outer Diameter	80 mm
d	35 mm
d1	37 mm
D	80 mm
D1	80 mm
T	34 mm

53407 Bearing 2D drawings and 3D CAD models